



NEW

Facade Drainage

Keeps your building dry.
Safe, reliable and versatile.



Our benefits with **HAURATON**:

„With **DACHFIX**[®]STEEL we have a safe system that accommodates even large amounts of heavy rain and melt water and keeps the building dry.“



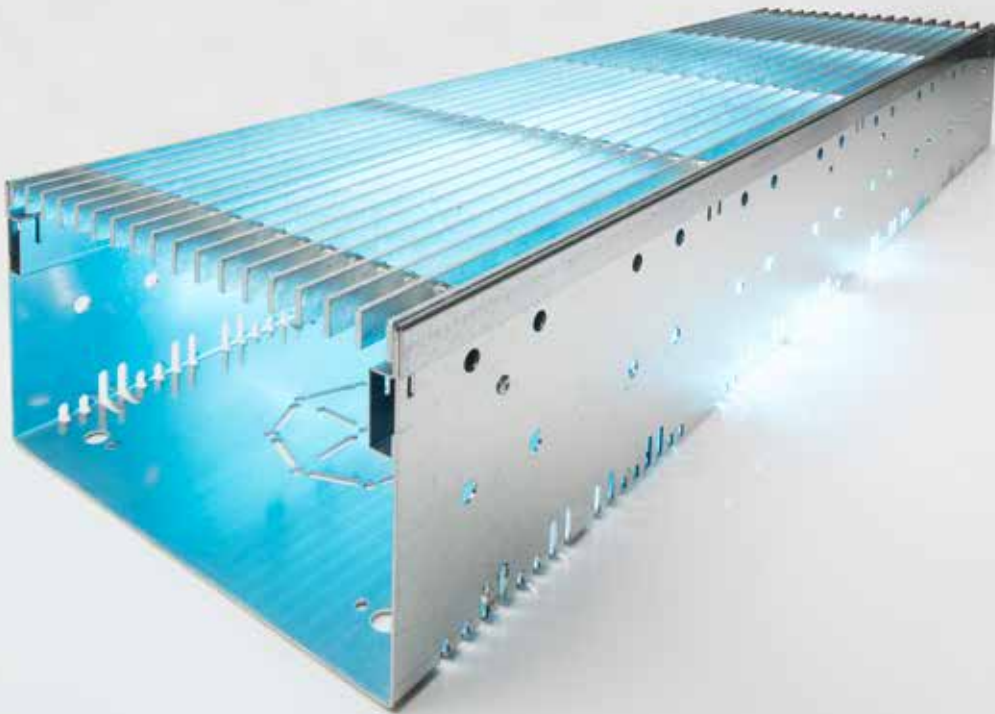

NEW



DACHFIX® STEEL
For standard facade drainage.

4



DACHFIX® STEEL
The right channel for every installation situation.

6



DACHFIX® STEEL
Application areas of **DACHFIX® STEEL** channels.

10



Customer benefits
How you benefit with **DACHFIX® STEEL**.

14



DACHFIX® STEEL
Product range.

18

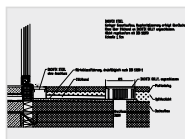

DACHFIX® STEEL
Installation examples.

48

DACHFIX® STEEL Channels

For standard facade drainage.

Facade drainage

The HAURATON DACHFIX channel range covers all installation situations with the best solutions. Moisture should never be allowed into a building through external areas such as doors and facades. HAURATON products ensure the protection. The channels meet all relevant regulations for facade drainage and provide the following benefits:

- large volumes of rainwater drained quickly and safely
- backflow reserve for sudden heavy rainfall
- avoidance of puddles forming around facade
- indoor areas safeguarded from heavy rainfall

Channels should not be lifted by strong winds and must prevent surface ponding. In many regions also snow, ice and slush requires handling efficiently. Heat permeating through doorways can quickly melt snow and ice, creating high volumes of surface water. This may be contained by remaining snow and ice. The DACHFIX range of facade drainage meets all these challenges and more, providing continuous and efficient surface drainage. Correct channel sizing to accommodate for anticipated surface water volumes is provided through comprehensive technical support available from HAURATON.

High architectural standards are maintained through a wide variety of grating designs and combinations: in both galvanised and stainless steel.

Well-known practical requirements

Height differences from 15 to 0 cm are familiar in the area of building drainage. Without a drainage system a level difference of 15 cm is required. This can be reduced to 5 cm with the use of DACHFIX STEEL. For safety reasons, many buildings are planned with a 5-cm level difference between indoor areas and water-bearing levels. However, this means that these buildings are not barrier-free accessible.

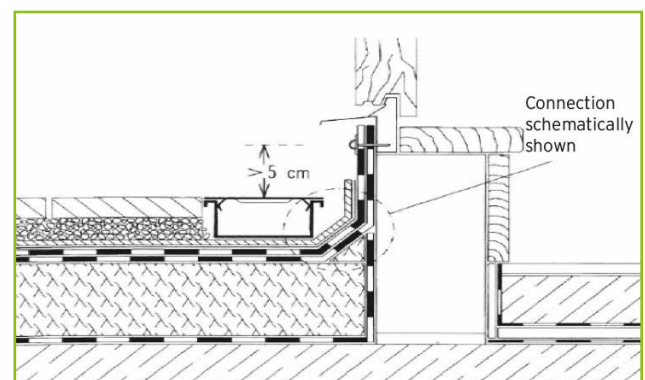

Practical requirements for barrier-free entrances

In practice, a 2 cm-high threshold is often accepted as barrier-free. However, in many public buildings a totally level surface (zero level) is used for handicapped-accessible and barrier-free access. To achieve this, entrances, exits and adjacent surfaces must be precisely constructed with no height differences. DACHFIX STEEL channels can meet both installation scenarios.

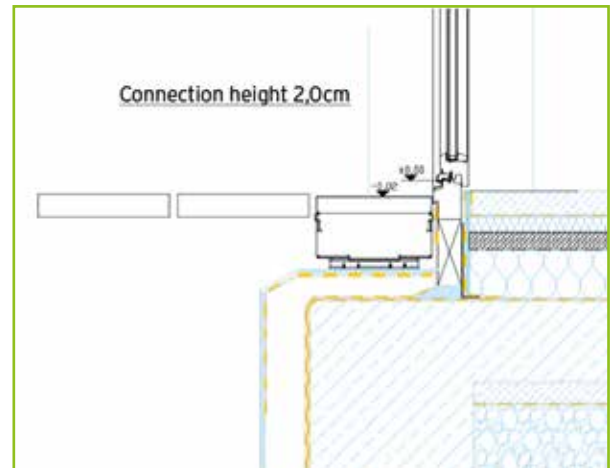

Accessibility

Barrier-free entrance: Through precise height adjustment to the floor, DACHFIX STEEL can be fully adapted to suit any environment. HAURATON meets the regulations, high standards and expectations of architects and planners regarding design of barrier-free buildings.



Standard entrance



Particularly essential for people with disabilities
no full stop needed

DACHFIX® STEEL Channels

The right channel for every installation situation.

Typical on-site installation examples

The DACHFIX STEEL channel range covers all standard installation situations and provides the best solution for every purpose.

Important for all installation situations: special attention to height level

If the channels are not connected to the wastewater pipe (installation situations A + B), a level difference of 5 cm between indoor areas and water-bearing levels should be observed. These buildings are not barrier-free accessible. In order to make entrances with a 2-cm difference in level or barrier-free (0 cm), a direct connection to the wastewater drainage system ensures reliable drainage (see installation situations C - E).

Installation situation A - Drainage via cross-intersection channel and DACHFIX®POINT

- Minimal overall construction, eg. roof terraces (no permeability).
- Drainage of water over a damp-proof-membrane through DACHFIX POINT.
- DACHFIX STEEL channel is connected to DACHFIX POINT via the cross-intersection channel. This ensures continuous drainage even when the roof structure is obstructed by fine particles and infiltration is reduced.



Installation situation B - Drainage without pipe connection to channel, 5 cm threshold

- Solution for reveal area with exit threshold.
- Channels installed with permeable concrete.
- Channels are perforated without pipe connection.
The water percolates underground.



DACHFIX® STEEL Channels

The right channel for every installation situation.

Installation situation C - Drainage via channel with vertical pipe connection, level entrance (0 cm)

- Solution for reveal area without substructure.
- Channels are perforated. Some of the the water is percolated underground.
- Channels installed with permeable concrete.
- Direct connection of channel to wastewater drainage system.



Installation situations D + E - Drainage via drain box, horizontal & vertical connection

- Solutions for a connection at the substructure reveal area with minimal overall construction.
- Channels are perforated. Some of the water percolates underground.
- Channels installed with permeable concrete.
- Direct connection of DACHFIX drain box to wastewater drainage system.



DACHFIX® STEEL Channels

The right channel for every installation situation.

NEW

Always the right channel for every installation application

DACHFIX STEEL channels were specifically developed for all practical installation applications. A wide range, with 5 widths each in 4 heights, covers project requirements and provides reliable drainage and effective splash-water protection in every case.

- 5 widths (115, 135, 155, 205, 255 mm) each in 4 heights (45, 75, 100, 150 mm)
- the right channel for every application
- large channel widths to capture splash water
- solution for reveal area without substructure
- perforations in channel base for percolation of subsurface water
- channels installed with permeable concrete
- wastewater pipe connection direct to channel
- channels are perforated and connected to DACHFIX drain box via vertical connection

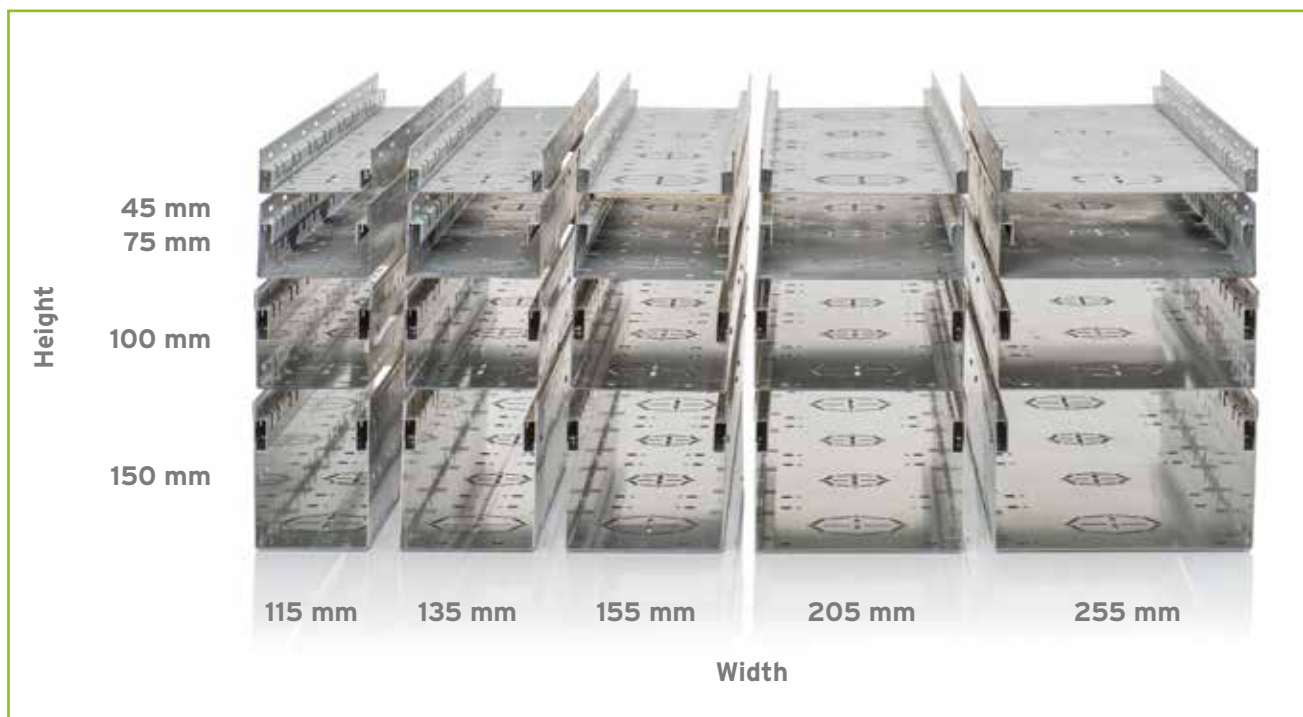

The scope of design is created by the wide range of different grating options.

Whether a slotted, mesh, perforated or longitudinal grating - the product range always provides the right solution.

Unique: The DACHFIX® drain box

Reveals are provided with thermal insulation and therefore require drainage channels with shallow inverts. In this case there is no possibility for a positive pipe connection (vertical or horizontal).

The DACHFIX drain box sits on top of the protruding insulation board to provide positive connection to the channel and carry water to a discharge point beyond the structure; with the option for vertical or horizontal pipe connection at least 15 cm lower than the channel invert.

- allows a vertical or horizontal connection with substructure areas (reveal, thermal insulation)
- can be installed with 25 x 25 cm standard tiles without being cut
- 2 drain box designs are compatible with all DACHFIX STEEL channels
- matching gratings provide uniform appearance with DACHFIX STEEL channels

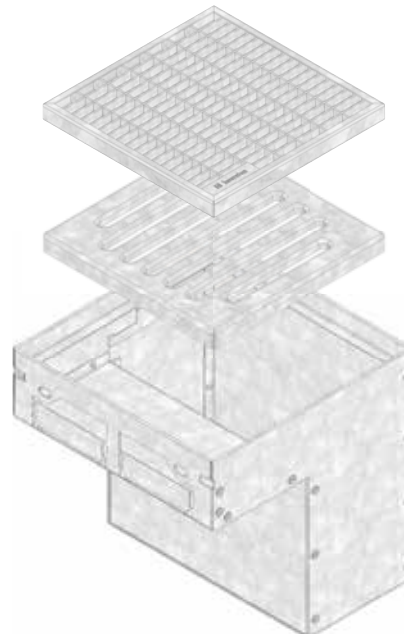
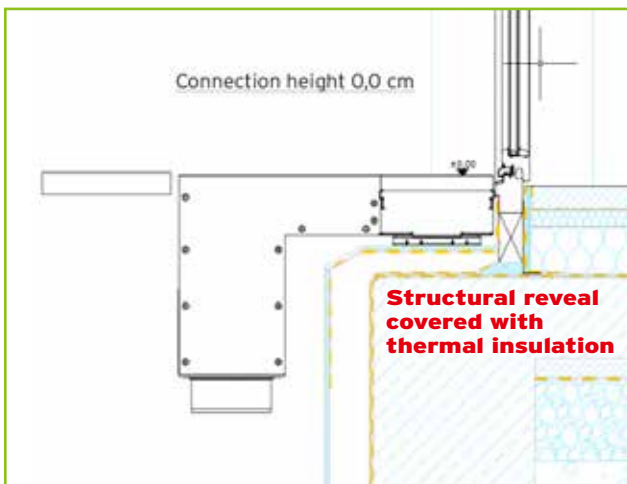

DACHFIX® STEEL Channels

Application areas for DACHFIX® STEEL Channels.

Security in planning and implementation

DACHFIX STEEL channels are especially developed for reliable and safe drainage of facades and flat roofs. The channels permanently protect buildings from standing or pressurised water while enabling entrances and passages to be made accessible.

- wide variety of channels with different widths and heights
- cover all standard installation situations
- implementation in accordance with standards and guidelines
- wide range of gratings for design flexibility
- hydraulic calculation provided by HAURATON Project Management Team

Application areas

- facades
- roof terraces
- flat roofs
- floor areas
- substructured reveal areas





Residential area, Sindelfingen



Adalbert-Stifter-School, Nuremberg



Penthouse, Wiehl



Leonardo Royal Hotel, Munich

The benefits of **DACHFIX®** STEEL Channels



One Product Range for all Installation Situations

- five widths: 115 mm, 135 mm, 155 mm, 205 mm and 255 mm
- four heights: 45 mm, 75 mm, 100 mm and 150 mm
- accommodates large volume of water/ melt water

= Flexibility / Security



Removable Section in Base

- easier on-site connection
- connection: DN 70 and DN 100

= Flexibility/Cost Savings

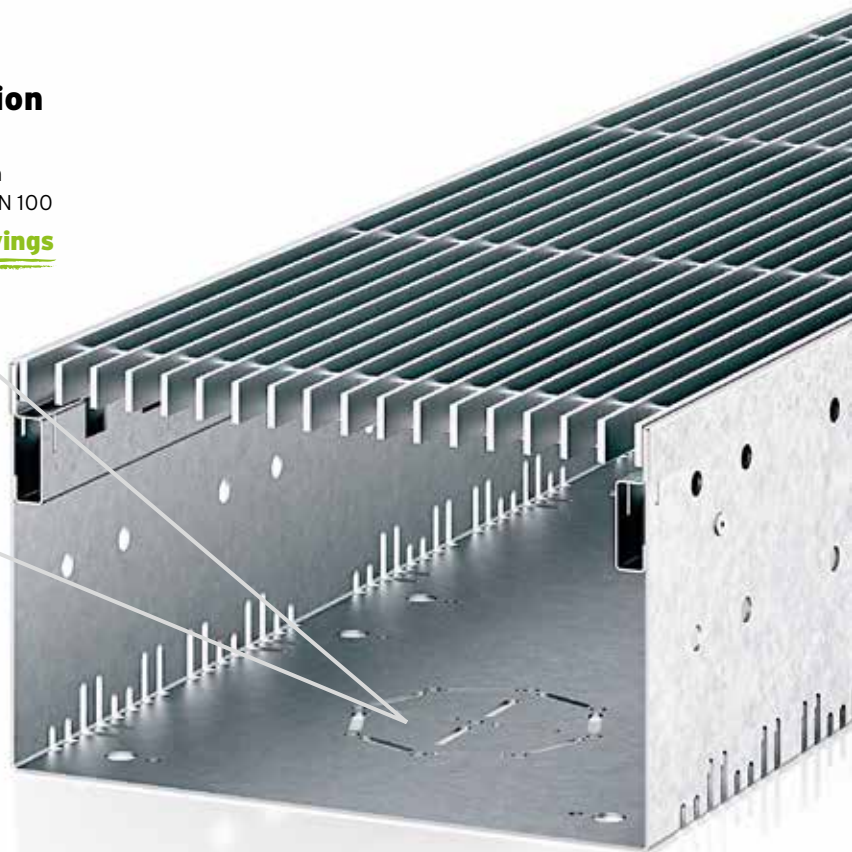

Practical Height Adjustment

- easy adjustment on uneven surfaces
- simple handling with 2 set screws
- placeable at several positions in the channel

= Flexibility

NEW

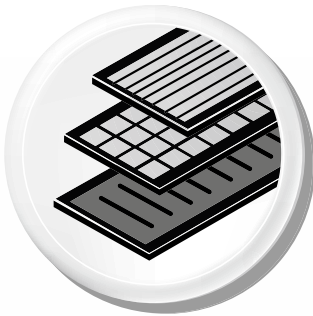

Numerous Grating Options

- made of recycled composite, galvanised steel, stainless steel
- aesthetic mesh and longitudinal gratings
- customised gratings available

= Flexibility

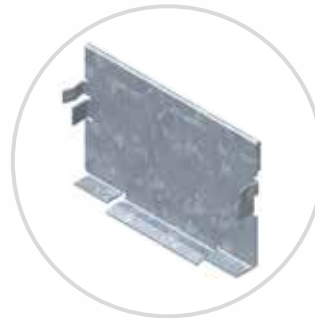
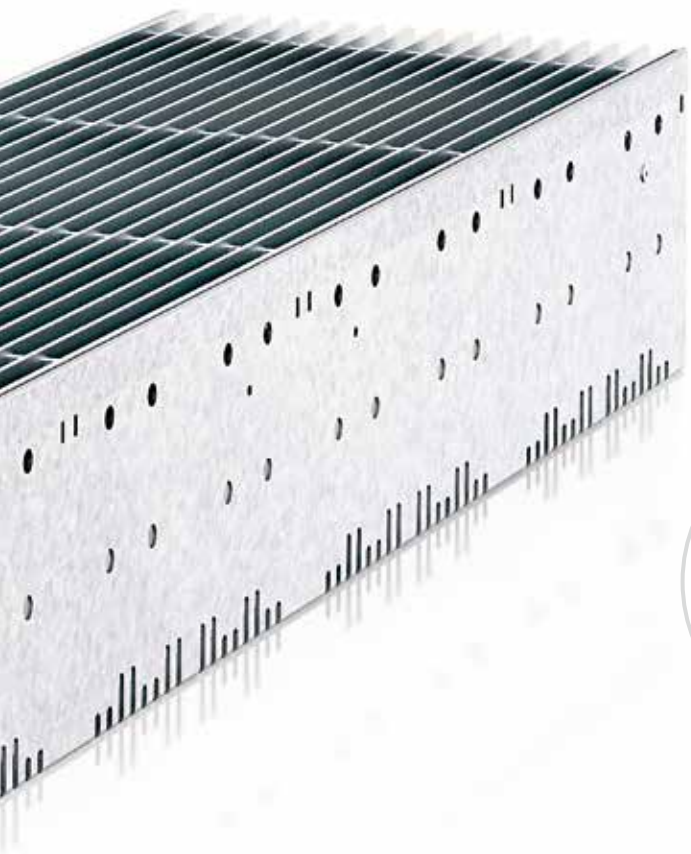

Unique End Cap

- easy to fix with clip function

= Cost Savings

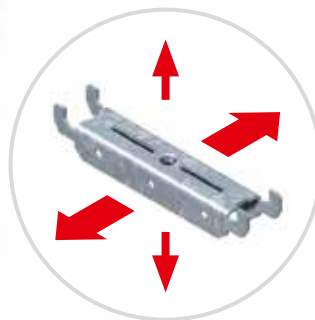

Special Locking Handle System

- locking handle for:
 - easy connection of channel elements
 - additional fixing option of grating

= Security



Easy Connection Options

- direct connection via removable section in base (DN 70 + DN 100)
- drain box outlet in substructure; vertical or horizontal connection
- via cross-intersection channel to DACHFIX®POINT

= Cost Savings / Flexibility / Security

DACHFIX® STEEL Channels

Reliable backwater reserve for terraces, facades and flat roofs.

DACHFIX Channels are suitable for pedestrian traffic and wheelchair access.

New drainage system

The new DACHFIX STEEL channel range includes many practical details that makes this system unique. Installation and processing are more simple and guarantee success.



Various grating options, for example mesh grating, slotted grating, perforated grating and longitudinal grating, available in these materials; recycled composite, galvanised steel, stainless steel.

Locking system for easy connection of channel unit or optional screw fastening of grating, retrofittable at any time.

Channel made of galvanised steel or stainless steel, in different widths and heights with pre-perforated punch outs DN 70 and DN 100 for optimal connection possibility.

Optional height adjustment for all widths and heights.

End cap for channel opening and end with clip-function for secure locking.

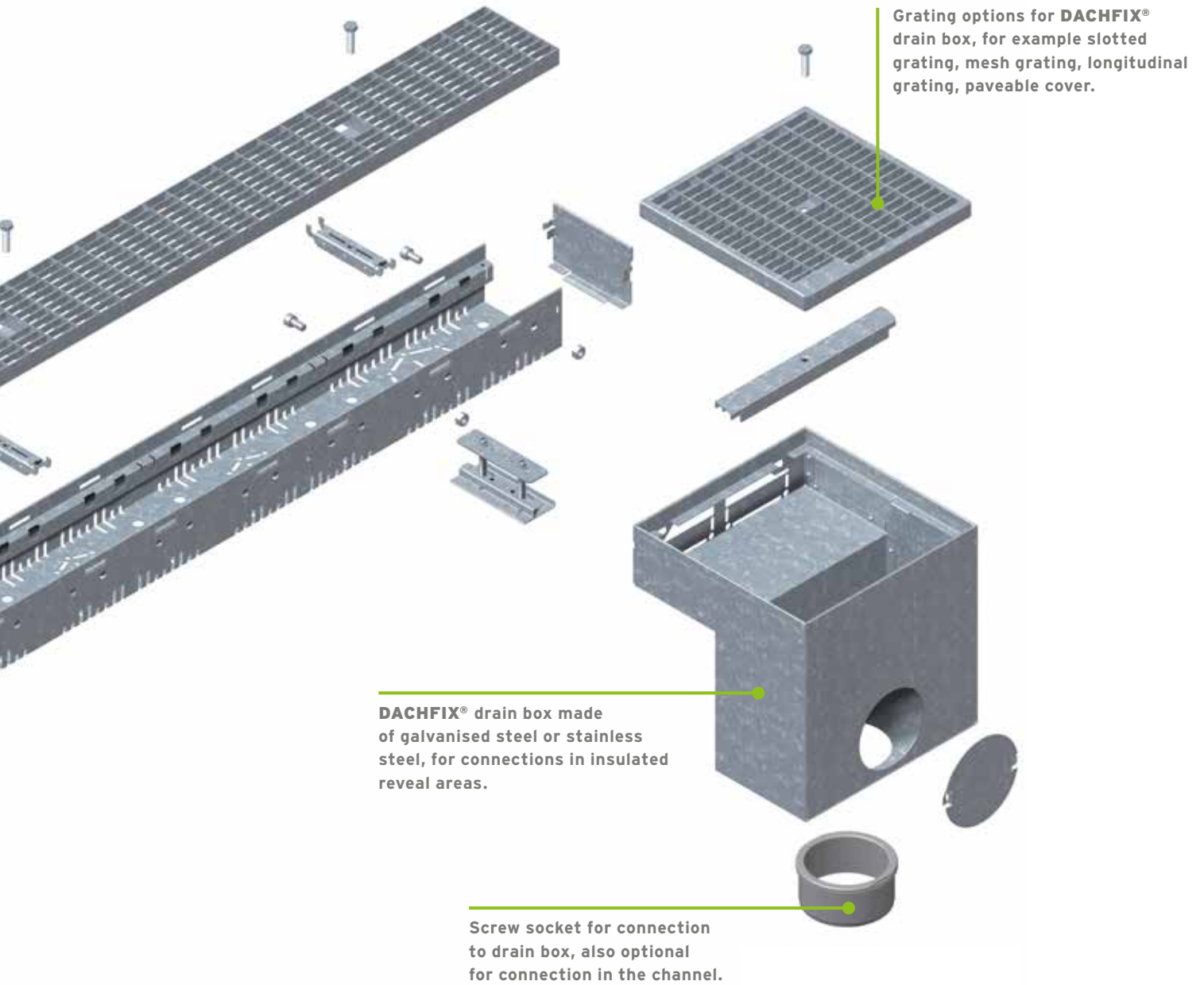

DACHFIX®STEEL 115

Channels

DACHFIX®STEEL 115, height 45 mm

Type 45



	Length mm	Width mm	Height mm	Drainage cross-sect. cm ²	Weight kg	Item-No. galvanised	Item-No. stainless steel
Type 45	1000	115	45	27	2,1	65000	65010

The quality of stainless steel material corresponds to CNS 1.4301.

DACHFIX®STEEL 115, height 75 mm

Type 75

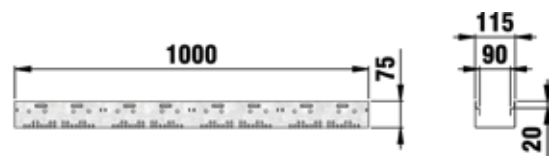
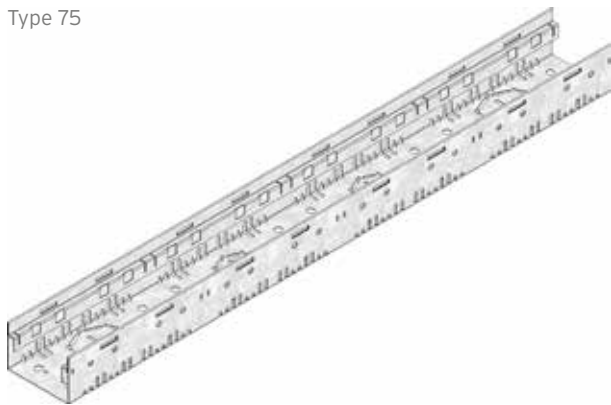

	Length mm	Width mm	Height mm	Drainage cross-sect. cm ²	Weight kg	Item-No. galvanised	Item-No. stainless steel
Type 75	1000	115	75	60	2,5	65025	65035

The quality of stainless steel material corresponds to CNS 1.4301.

DACHFIX®STEEL 115

DACHFIX®STEEL 115, height 100 mm

Type 100, galvanised

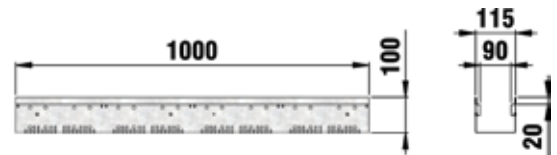

	Length mm	Width mm	Height mm	Drainage cross-sect. cm ²	Weight kg	Item No.
Type 100, galvanised	1000	115	100	87	4,7	65050

DACHFIX®STEEL 115, height 150 mm

Type 150, galvanised

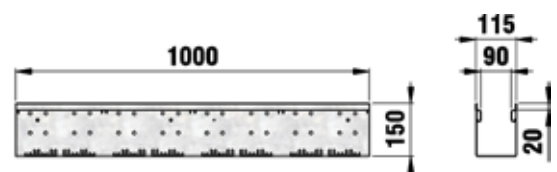

	Length mm	Width mm	Height mm	Drainage cross-sect. cm ²	Weight kg	Item No.
Type 150, galvanised	1000	115	150	142	5,9	65075

DACHFIX®STEEL 115

Channels

DACHFIX®STEEL 115, height adjustable

Type 45



	Length mm	Width mm	Height mm	Drainage cross-sect. cm ²	Weight kg	Item No.
Type 45, height adjustable, galvanised	1000	115	59 - 74	27	2,4	65003
Type 45, height adjustable, stainless steel	1000	115	59 - 74	27	2,4	65013
Type 75, height adjustable, galvanised	1000	115	89 - 124	60	2,9	65028
Type 75, height adjustable, stainless steel	1000	115	89 - 124	60	2,9	65038
Type 100, height adjustable, galvanised	1000	115	114 - 149	87	4,9	65053
Type 100, height adjustable, stainless steel	1000	115	114 - 149	87	6,8	65063
Type 150, height adjustable, galvanised	1000	115	164 - 199	142	6,3	65078
Type 150, height adjustable, stainless steel	1000	115	164 - 199	142	6,3	65088

The quality of stainless steel material corresponds to CNS 1.4301.

DACHFIX®STEEL 115

Gratings

DACHFIX®STEEL 115

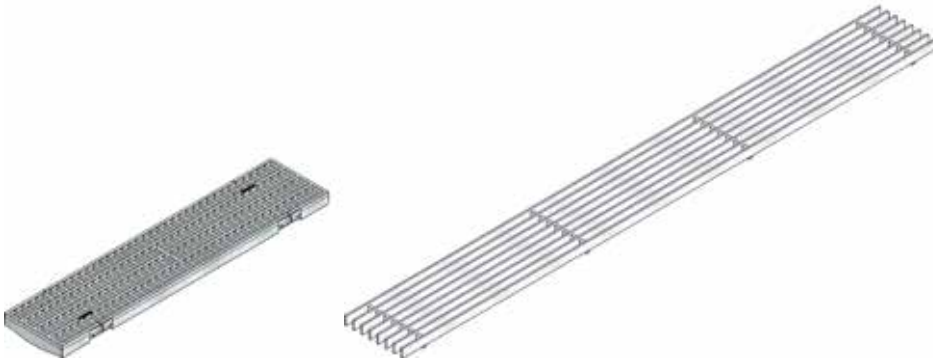

Mesh grating, PP, silver,
MW 30/10

Longitudinal grating

	Length mm	Width mm	Height mm	Intake cross-sect. cm ² /m	Weight kg	Item-No. galvanised	Item-No. stainless steel
Mesh grating, PP, silver, MW 8/21	500	108	20	509	0,4	69024	-
Mesh grating, PP, black, MW 8/21	500	108	20	509	0,4	69025	-
Mesh grating MW 30/10	1000	108	20	871	2,3	69020	69022
Longitudinal grating made of PP	500	108	20	650	-	69066	-
Longitudinal grating	1000	108	20	822	3,2	60900	60905
Slotted grating	1000	108	20	256	1,2	69026	69030
Perforated grating	1000	108	20	104	1,8	60950	60955

The quality of stainless steel material corresponds to CNS 1.4301.

DACHFIX® STEEL 115

Accessories

Drain box, base



Drain box for type 45, 75



Drain box for type 100, 150



Drain box for type 100, 150 with paveable cover

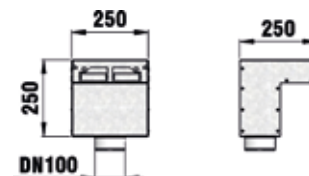

	Length mm	Width mm	Height mm	Weight kg	Item-No. galvanised	Item-No. stainless steel
Drain box for type 45, 75	250	250	250	2,3	65501	65508
Drain box for type 100, 150	250	250	250	2,4	65504	65511
Drain box for type 100, 150 with paveable cover	250	250	250	6,1	65505	65515

The quality of stainless steel material corresponds to CNS 1.4301.

Drain box, grating



Slotted grating



Mesh grating,
MW 30/10

	Length mm	Width mm	Height mm	Intake cross-sect. cm ² /m	Weight kg	Item-No. galvanised	Item-No. stainless steel
Slotted grating	242	242	20	116	1,1	60524	60534
Mesh grating, MW 30/10	242	242	20	398	1,2	60521	60531

The quality of stainless steel material corresponds to CNS 1.4301.

DACHFIX® STEEL 115

Accessories

End caps



End cap type 45, closed



End cap type 100, closed



End cap type 150, closed

	Length mm	Width mm	Height mm	Weight kg	Item-No. galvanised	Item-No. stainless steel
End cap type 45, closed	-	-	-	0,1	65019	65020
End cap type 75, closed	-	-	-	0,1	65044	65045
End cap type 100, closed	-	-	-	0,1	65069	-
End cap type 150, closed	-	-	-	0,2	65094	-

The quality of stainless steel material corresponds to CNS 1.4301.

Further accessories



Height adjusting set DACHFIX STEEL 115, type 45
(2 pieces per metre required)



Cross-intersection channel, galvanised



Locking handle, for DACHFIX STEEL 115



Screw socket DN 70

	Length mm	Width mm	Height mm	Weight kg	Item-No. galvanised	Item-No. stainless steel
Height adjusting set DACHFIX STEEL 115, type 45 (2 pieces per metre required)	45	108	36	0,2	65550	65551
Height adjusting set DACHFIX STEEL 115, type 75, 100, 150 (2 pieces per metre required)	45	108	56	0,2	65570	65571
Cross-intersection channel	1000	70	30	0,7	60800	60801
Locking handle, for DACHFIX STEEL 115	-	-	-	0,1	61075	61275
Locking handle set with bolt for mesh grating	-	-	-	0,1	65592	65593
Locking handle set with bolt for perforated grating	-	-	-	0,1	65595	65596
Locking handle set with bolt for longitudinal grating	-	-	-	0,1	65598	65599
Screw socket DN 70	-	-	-	0,1	1187	-
Screw socket DN 100, grey	-	-	-	0,1	1185	-
Adapter for screw socket DN 70 to pipe connection	-	-	-	0,1	1193	-
Adapter for screw socket DN 100 to pipe connection	-	-	-	0,1	1192	-
Leaf trap for screw socket DN 70, grey	-	-	-	-	1188	-
Leaf trap for screw socket DN 100, grey	-	-	-	-	1190	-

The quality of stainless steel material corresponds to CNS 1.4301.

DACHFIX®STEEL 135

Channels

DACHFIX®STEEL 135, height 45 mm

Type 45



	Length mm	Width mm	Height mm	Drainage cross-sect. cm ²	Weight kg	Item-No. galvanised	Item-No. stainless steel
Type 45	1000	135	45	32	2,2	65100	65110

The quality of stainless steel material corresponds to CNS 1.4301.

DACHFIX®STEEL 135, height 75 mm

Type 75



	Length mm	Width mm	Height mm	Drainage cross-sect. cm ²	Weight kg	Item-No. galvanised	Item-No. stainless steel
Type 75	1000	135	75	71	2,7	65125	65135

The quality of stainless steel material corresponds to CNS 1.4301.

DACHFIX®STEEL 135

DACHFIX®STEEL 135, height 100 mm

Type 100, galvanised



	Length mm	Width mm	Height mm	Drainage cross-sect. cm ²	Weight kg	Item-No. galvanised	Item-No. stainless steel
Type 100, galvanised	1000	135	100	103	5,0	65150	-

DACHFIX®STEEL 135, height 150 mm

Type 150, galvanised

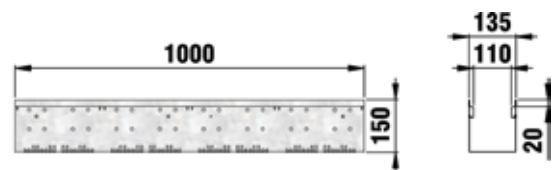

	Length mm	Width mm	Height mm	Drainage cross-sect. cm ²	Weight kg	Item-No. galvanised	Item-No. stainless steel
Type 150, galvanised	1000	135	150	169	6,2	65175	-

DACHFIX®STEEL 135

Channels

DACHFIX®STEEL 135, height adjustable

Type 75

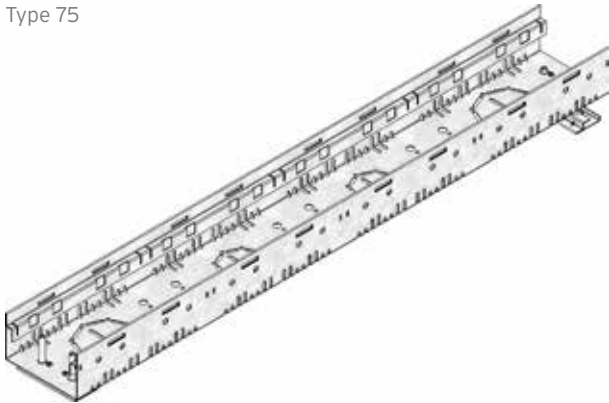

	Length mm	Width mm	Height mm	Intake cross-sect. cm ² /m	Weight kg	Item No.
Type 45, height adjustable, galvanised	1000	135	59 - 74	32	2,5	65103
Type 45, height adjustable, stainless steel	1000	135	59 - 74	32	3,0	65113
Type 75, height adjustable, galvanised	1000	135	89 - 124	71	3,1	65128
Type 75, height adjustable, stainless steel	1000	135	89 - 124	71	3,1	65138
Type 100, height adjustable, galvanised	1000	135	114 - 149	103	5,3	65153
Type 100, height adjustable, stainless steel	1000	135	114 - 149	103	5,4	65163
Type 150, height adjustable, galvanised	1000	135	164 - 199	169	6,5	65178
Type 150, height adjustable, stainless steel	1000	135	164 - 199	169	6,4	65188

The quality of stainless steel material corresponds to CNS 1.4301.

DACHFIX®STEEL 135

Gratings

DACHFIX®STEEL 135

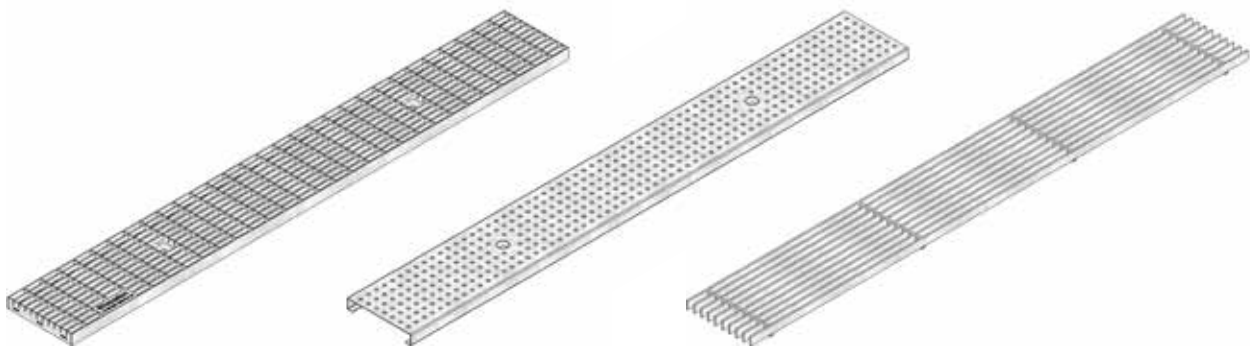

Mesh grating
MW 30/10

Perforated grating

Longitudinal grating

	Length mm	Width mm	Height mm	Intake cross-sect. cm ² /m	Weight kg	Item-No. galvanised	Item-No. stainless steel
Mesh grating MW 30/10	1000	129	20	1055	2,3	69001	69011
Perforated grating	1000	129	20	120	2,0	69035	69041
Longitudinal grating	1000	129	20	958	4,1	69047	69057

The quality of stainless steel material corresponds to CNS 1.4301.

DACHFIX® STEEL 135

Accessories

Drain box, base



Drain box for type 45, 75



Drain box for type 100, 150



Drain box for type 100, 150 with paveable cover

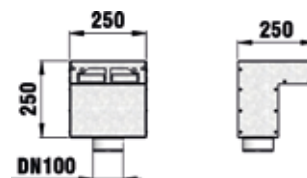

	Length mm	Width mm	Height mm	Weight kg	Item-No. galvanised	Item-No. stainless steel
Drain box for type 45, 75	250	250	250	2,3	65501	65508
Drain box for type 100, 150	250	250	250	2,4	65504	65511
Drain box for type 100, 150 with paveable cover	250	250	250	6,1	65505	65515

The quality of stainless steel material corresponds to CNS 1.4301.

DACHFIX® Drain box, grating



Slotted grating



Mesh grating,
MW 30/10

	Length mm	Width mm	Height mm	Intake cross-sect. cm ² /m	Weight kg	Item-No. galvanised	Item-No. stainless steel
Slotted grating	242	242	20	116	1,1	60524	60534
Mesh grating, MW 30/10	242	242	20	398	1,2	60521	60531

The quality of stainless steel material corresponds to CNS 1.4301.

DACHFIX® STEEL 135

Accessories

End caps



End cap type 75, closed

End cap type 150, closed

	Length mm	Width mm	Height mm	Weight kg	Item-No. galvanised	Item-No. stainless steel
End cap type 45, closed	-	-	-	0,1	65119	65120
End cap type 75, closed	-	-	-	0,1	65144	65145
End cap type 100, closed	-	-	-	0,1	65169	-
End cap type 150, closed	-	-	-	0,2	65194	-

The quality of stainless steel material corresponds to CNS 1.4301.

Further accessories



Height adjustment set
DACHFIX STEEL 135, type 45
(2 pieces per metre required)

Screw socket DN 70

Screw socket DN 100

	Length mm	Width mm	Height mm	Weight kg	Item-No. galvanised	Item-No. stainless steel
Height adjusting set DACHFIX STEEL 135, type 45 (2 pieces per metre required)	45	108	36	0,2	65553	65554
Height adjusting set DACHFIX STEEL 135, type 75, 100, 150 (2 pieces per metre required)	45	108	56	0,2	65573	65574
Cross-intersection channel	1000	70	30	0,7	60800	60801
Locking handle, for DACHFIX STEEL135	-	-	-	0,1	65585	65586
Locking handle set with bolt for mesh grating	-	-	-	0,1	69100	69104
Locking handle set with bolt for perforated grating	-	-	-	0,1	69108	69112
Locking handle set with bolt for longitudinal grating	-	-	-	0,1	69116	69120
Screw socket DN 70	-	-	-	-	1187	-
Screw socket DN 100, grey	-	-	-	0,1	1185	-
Adapter for screw socket DN 70 to pipe connection	-	-	-	0,1	1193	-
Adapter for screw socket DN 100 to pipe connection	-	-	-	0,1	1192	-
Leaf trap for screw socket DN 70, grey	-	-	-	-	1188	-
Leaf trap for screw socket DN 100, grey	-	-	-	-	1190	-

The quality of stainless steel material corresponds to CNS 1.4301.

DACHFIX®STEEL 155

Channels

DACHFIX®STEEL 155, height 45 mm

Type 45, galvanised



	Length mm	Width mm	Height mm	Drainage cross-sect. cm ²	Weight kg	Item No.
Type 45, galvanised	1000	155	45	37	2,4	65200

DACHFIX®STEEL 155, height 75 mm

Type 75, galvanised



	Length mm	Width mm	Height mm	Drainage cross-sect. cm ²	Weight kg	Item No.
Type 75, galvanised	1000	155	75	83	2,9	65225

DACHFIX®STEEL 155

DACHFIX®STEEL 155, height 100 mm

Type 100, galvanised



	Length mm	Width mm	Height mm	Drainage cross-sect. cm ²	Weight kg	Item No.
Type 100, galvanised	1000	155	100	120	5,1	65250

DACHFIX®STEEL 155, height 150 mm

Type 150, galvanised

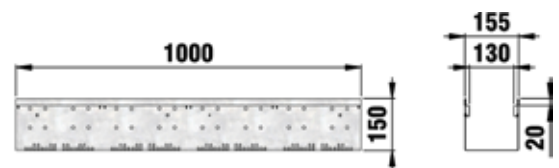

	Length mm	Width mm	Height mm	Drainage cross-sect. cm ²	Weight kg	Item No.
Type 150, galvanised	1000	155	150	196	6,3	65275

DACHFIX®STEEL 155

Channels

DACHFIX®STEEL 155, height adjustable

Type 100

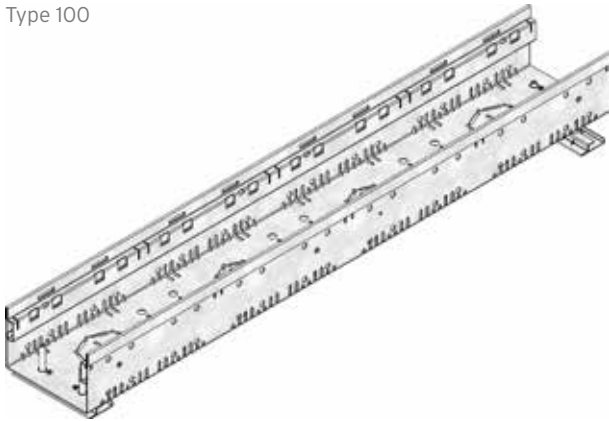

	Length mm	Width mm	Height mm	Drainage cross-sect. cm ²	Weight kg	Item No.
Type 45, height adjustable, galvanised	1000	155	59 - 74	37	2,8	65203
Type 75, height adjustable, galvanised	1000	155	89 - 124	83	3,1	65228
Type 100, height adjustable, galvanised	1000	155	114 - 149	120	5,6	65253
Type 150, height adjustable, galvanised	1000	155	164 - 199	196	6,7	65278

DACHFIX®STEEL 155

Gratings

DACHFIX®STEEL 155

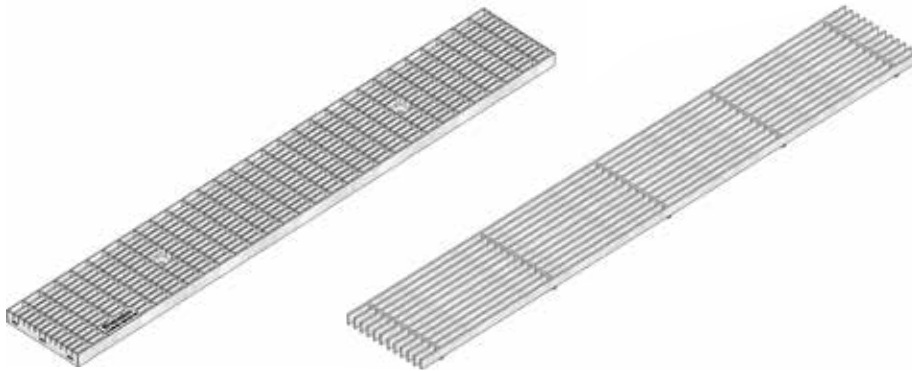

Mesh grating MW 30/10,
galvanised

Longitudinal grating,
galvanised

	Length mm	Width mm	Height mm	Intake cross-sect. cm ² /m	Weight kg	Item-No. galvanised	Item-No. stainless steel
Mesh grating MW 30/10 , galvanised	1000	149	20	1099	3,8	69002	-
Longitudinal grating, galvanised	1000	149	20	1099	4,9	69048	-
Perforated grating	1000	149	20	99	5,2	69036	69042
Perforated grating	500	149	20	99	2,6	69039	69045

The quality of stainless steel material corresponds to CNS 1.4301.

DACHFIX® STEEL 155

Accessories

Drain box, base



Drain box for type 45, 75

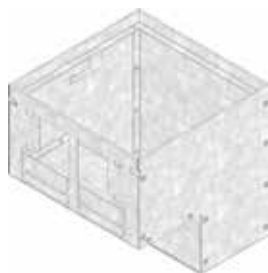

Drain box for type 100, 150



Drain box for type 100, 150 with paveable cover

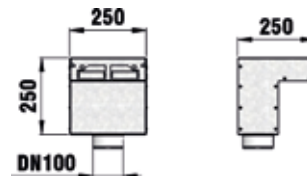

	Length mm	Width mm	Height mm	Weight kg	Item-No. galvanised	Item-No. stainless steel
Drain box for type 45, 75	250	250	250	2,3	65501	65508
Drain box for type 100, 150	250	250	250	2,4	65504	65511
Drain box for type 100, 150 with paveable cover	250	250	250	6,1	65505	65515

The quality of stainless steel material corresponds to CNS 1.4301.

DACHFIX® Drain box, grating



Slotted grating



Mesh grating,
MW 30/10

	Length mm	Width mm	Height mm	Intake cross-sect. cm ² /m	Weight kg	Item-No. galvanised	Item-No. stainless steel
Slotted grating	242	242	20	116	1,1	60524	60534
Mesh grating, MW 30/10	242	242	20	398	1,2	60521	60531

The quality of stainless steel material corresponds to CNS 1.4301.

DACHFIX® STEEL 155

Accessories

End caps



End cap type 45, closed, galvanised



End cap type 100, closed, galvanised



End cap type 150, closed, galvanised

	Length mm	Width mm	Height mm	Weight kg	Item No.
End cap type 45, closed, galvanised	-	-	-	0,1	65219
End cap type 75, closed, galvanised	-	-	-	0,1	65244
End cap type 100, closed, galvanised	-	-	-	0,2	65269
End cap type 150, closed, galvanised	-	-	-	0,2	65294

Further accessories



Height adjusting set DACHFIX STEEL 155, type 45, galvanised (2 pieces per metre required)



Cross-intersection channel, galvanised



Screw socket DN 70



Screw socket DN 100, grey

	Length mm	Width mm	Height mm	Weight kg	Item-No. galvanised	Item-No. stainless steel
Height adjusting set DACHFIX STEEL 155, type 45, galvanised (2 pieces per metre required)	45	148	36	0,2	65556	-
Height adjusting set DACHFIX STEEL 155, type 75, 100, 150, galvanised (2 pieces per metre required)	45	148	56	0,2	65576	-
Cross-intersection channel	1000	70	30	0,7	60800	60801
Locking handle, for DACHFIX STEEL155	-	-	-	0,1	65587	65588
Locking handle set with bolt for mesh grating, galvanised	-	-	-	0,1	69101	-
Locking handle set with bolt for longitudinal grating, galvanised	-	-	-	0,1	69117	-
Screw socket DN 70	-	-	-	0,1	1187	-
Screw socket DN 100, grey	-	-	-	0,1	1185	-
Adapter for screw socket DN 70 to pipe connection	-	-	-	0,1	1193	-
Adapter for screw socket DN 100 to pipe connection	-	-	-	0,1	1192	-
Leaf trap for screw socket DN 70, grey	-	-	-	-	1188	-
Leaf trap for screw socket DN 100, grey	-	-	-	-	1190	-

The quality of stainless steel material corresponds to CNS 1.4301.

DACHFIX®STEEL 205

Channels

DACHFIX®STEEL 205, height 45 mm

Type 45, galvanised

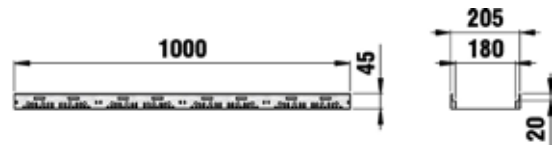

	Length mm	Width mm	Height mm	Drainage cross-sect. cm ²	Weight kg	Item No.
Type 45, galvanised	1000	205	45	49	2,8	65300

DACHFIX®STEEL 205, height 75 mm

Type 75, galvanised

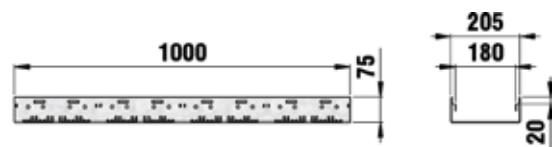
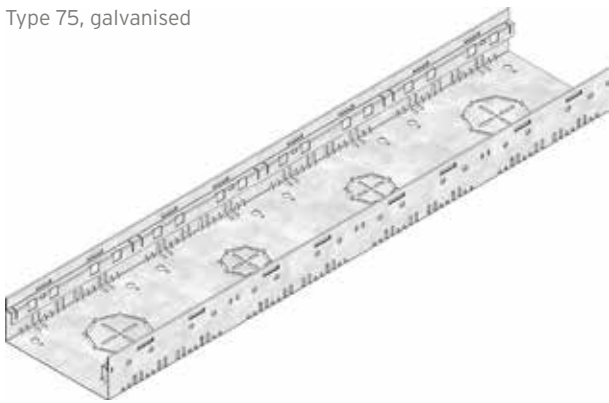

	Length mm	Width mm	Height mm	Drainage cross-sect. cm ²	Weight kg	Item No.
Type 75, galvanised	1000	205	75	110	3,2	65325

DACHFIX®STEEL 205

DACHFIX®STEEL 205, height 100 mm

Type 100, galvanised

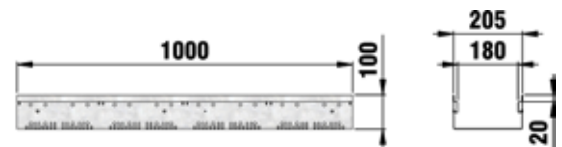

	Length mm	Width mm	Height mm	Drainage cross-sect. cm ²	Weight kg	Item No.
Type 100, galvanised	1000	205	100	159	5,7	65350

DACHFIX®STEEL 205, height 150 mm

Type 150, galvanised

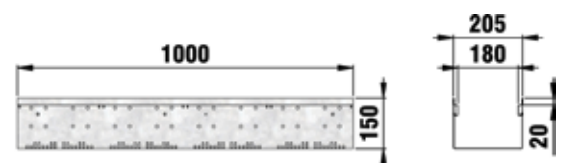

	Length mm	Width mm	Height mm	Drainage cross-sect. cm ²	Weight kg	Item No.
Type 150, galvanised	1000	205	150	260	6,9	65375

DACHFIX®STEEL 205

Channels

DACHFIX®STEEL 205, height adjustable

Type 150

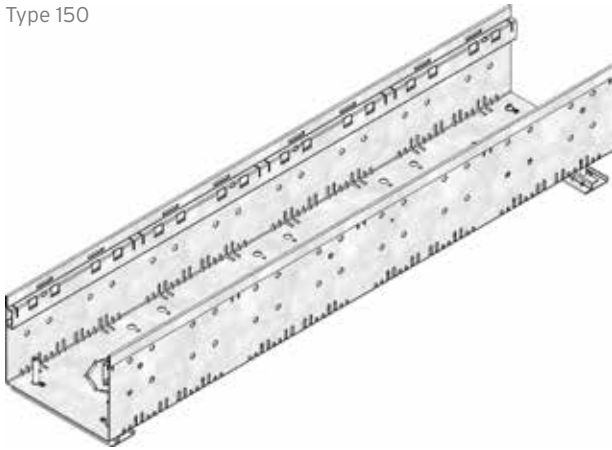

	Length mm	Width mm	Height mm	Drainage cross-sect. cm ²	Weight kg	Item No.
Type 45, height adjustable, galvanised	1000	205	59 - 74	49	3,3	65303
Type 75, height adjustable, galvanised	1000	205	89 - 124	110	3,8	65328
Type 100, height adjustable, galvanised	1000	205	114 - 149	159	6,3	65353
Type 150, height adjustable, galvanised	1000	205	164 - 199	260	7,4	65378

DACHFIX®STEEL 205

Gratings

DACHFIX®STEEL 205

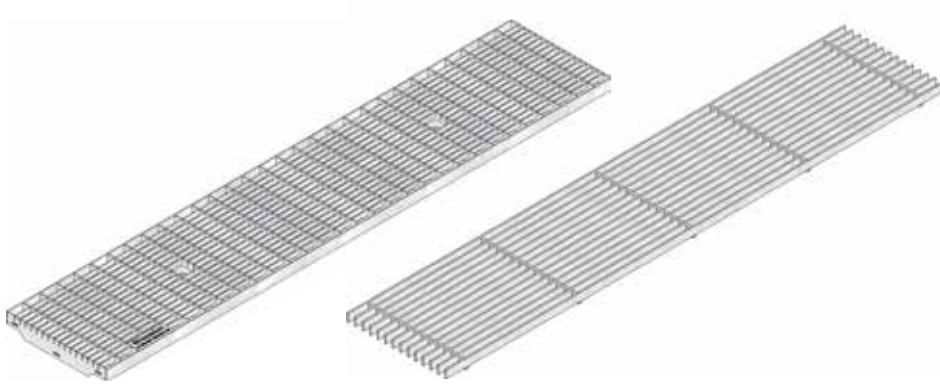

Mesh grating MW 30/10, galvanised

Longitudinal grating, galvanised

	Length mm	Width mm	Height mm	Intake cross-sect. cm ² /m	Weight kg	Item No.
Mesh grating MW 30/10, galvanised	1000	199	20	1490	5,3	69003
Longitudinal grating, galvanised	1000	199	20	1528	5,8	69049

DACHFIX® STEEL 205

Accessories

Drain box, base



Drain box for type 45, 75



Drain box for type 100, 150



Drain box for type 100, 150 with paveable cover

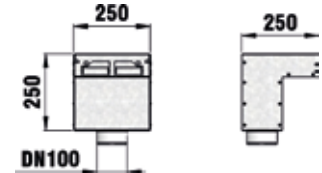

	Length mm	Width mm	Height mm	Weight kg	Item-No. galvanised	Item-No. stainless steel
Drain box for type 45, 75	250	250	250	2,3	65501	65508
Drain box for type 100,150	250	250	250	2,4	65504	65511
Drain box for type 100, 150 with paveable cover	250	250	250	6,1	65505	65515

The quality of stainless steel material corresponds to CNS 1.4301.

DACHFIX® Drain box, grating



Slotted grating



Mesh grating,
MW 30/10

	Length mm	Width mm	Height mm	Intake cross-sect. cm ² /m	Weight kg	Item-No. galvanised	Item-No. stainless steel
Slotted grating	242	242	20	116	1,1	60524	60534
Mesh grating, MW 30/10	242	242	20	398	1,2	60521	60531

The quality of stainless steel material corresponds to CNS 1.4301.

DACHFIX® STEEL 205

Accessories

End caps



End cap type 45,
closed, galvanised



End cap type 75,
closed, galvanised



End cap type 150,
closed, galvanised

	Length mm	Width mm	Height mm	Weight kg	Item No.
End cap type 45, closed, galvanised	-	-	-	0,1	65319
End cap type 75, closed, galvanised	-	-	-	0,2	65344
End cap type 100, closed, galvanised	-	-	-	0,2	65369
End cap type 150, closed, galvanised	-	-	-	0,3	65394

Further accessories



Height adjusting set DACHFIX
STEEL 205, type 45, galvanised
(2 pieces per metre required)



Cross-intersection channel,
galvanised



Screw socket DN 70

	Length mm	Width mm	Height mm	Weight kg	Item-No. galvanised	Item-No. stainless steel
Height adjusting set DACHFIX STEEL 205, type 45, galvanised (2 pieces per metre required)	45	198	36	0,3	65559	-
Height adjusting set DACHFIX STEEL 205, type 75, 100, 150, galvanised (2 pieces per metre required)	45	198	56	0,3	65579	-
Cross-intersection channel	1000	70	30	0,7	60800	60801
Locking handle, for DACHFIX STEEL 205	-	-	-	0,1	65589	65590
Locking handle set with bolt for mesh grating, galvanised	-	-	-	0,1	69102	-
Locking handle set with bolt for longitudinal grating, galvanised	-	-	-	0,1	69118	-
Screw socket DN 70	-	-	-	0,1	1187	-
Screw socket DN 100, grey	-	-	-	0,1	1185	-
Adapter for screw socket DN 70 to pipe connection	-	-	-	0,1	1193	-
Adapter for screw socket DN 100 to pipe connection	-	-	-	0,1	1192	-
Leaf trap for screw socket DN 70, grey	-	-	-	-	1188	-
Leaf trap for screw socket DN 100, grey	-	-	-	-	1190	-

The quality of stainless steel material corresponds to CNS 1.4301.

DACHFIX®STEEL 255

Channels

DACHFIX®STEEL 255, height 45 mm

Type 45, galvanised

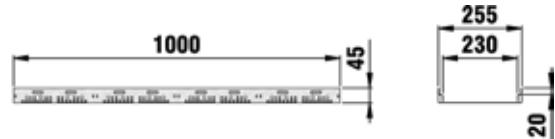
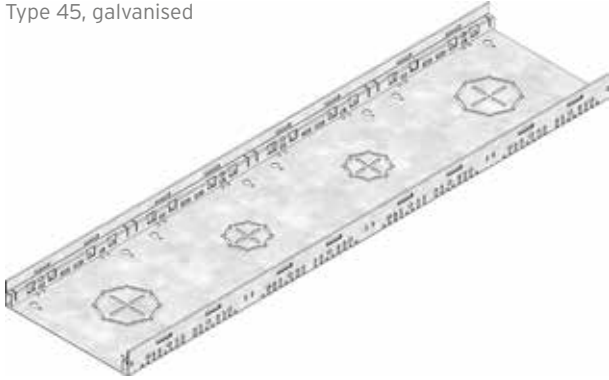

	Length mm	Width mm	Height mm	Drainage cross-sect. cm ²	Weight kg	Item No.
Type 45, galvanised	1000	255	45	61	3,1	65400

DACHFIX®STEEL 255, height 75 mm

Type 75, galvanised

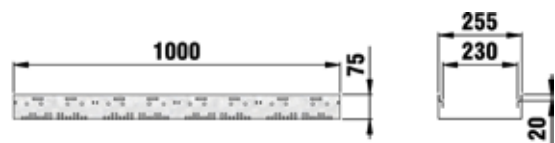
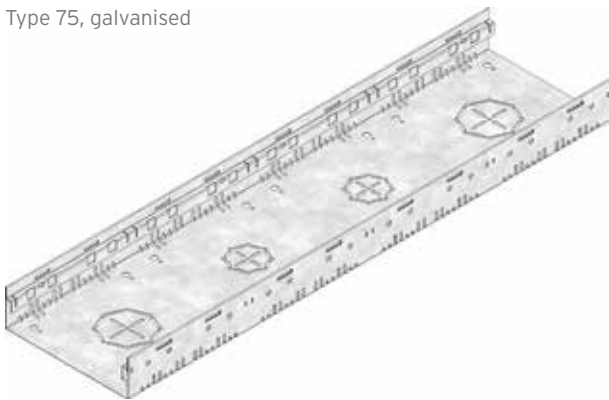

	Length mm	Width mm	Height mm	Drainage cross-sect. cm ²	Weight kg	Item No.
Type 75, galvanised	1000	255	75	137	3,6	65425

DACHFIX®STEEL 255

DACHFIX®STEEL 255, height 100 mm

Type 100, galvanised



	Length mm	Width mm	Height mm	Drainage cross-sect. cm ²	Weight kg	Item No.
Type 100, galvanised	1000	255	100	198	6,2	65450

DACHFIX®STEEL 255, height 150 mm

Type 150, galvanised

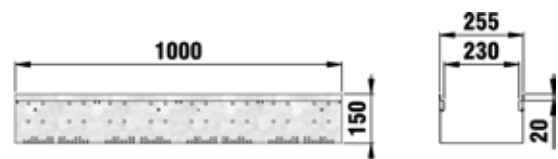

	Length mm	Width mm	Height mm	Drainage cross-sect. cm ²	Weight kg	Item No.
Type 150, galvanised	1000	255	150	324	7,5	65475

DACHFIX®STEEL 255

Channels

DACHFIX®STEEL 255, height adjustable

Type 45

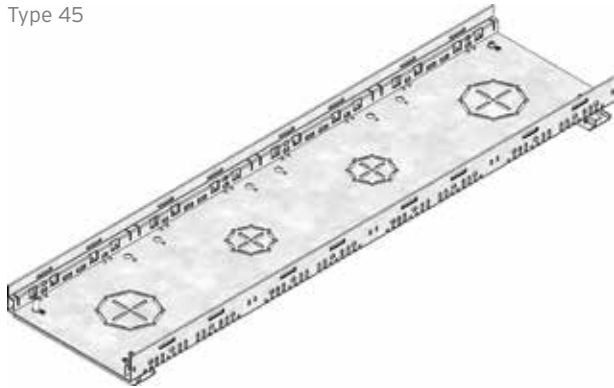

	Length mm	Width mm	Height mm	Drainage cross-sect. cm ²	Weight kg	Item No.
Type 45, height adjustable, galvanised	1000	255	59 - 74	61	3,8	65403
Type 75, height adjustable, galvanised	1000	255	89 - 124	137	4,0	65428
Type 100, height adjustable, galvanised	1000	255	114 - 149	198	6,9	65453
Type 150, height adjustable, galvanised	1000	255	164 - 199	324	8,2	65478

DACHFIX®STEEL 255

Gratings

DACHFIX®STEEL 255

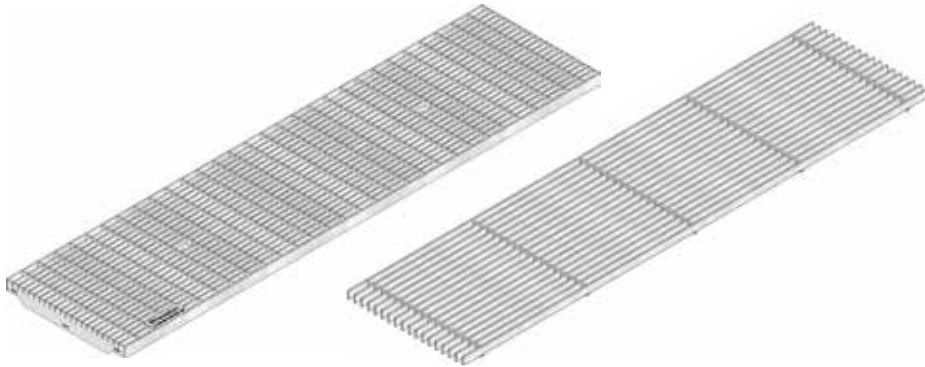

Mesh grating MW 30/10,
galvanised

Longitudinal grating,
galvanised

	Length mm	Width mm	Height mm	Intake cross-sect. cm ² /m	Weight kg	Item No.
Mesh grating MW 30/10, galvanised	1000	249	20	1873	7,3	69004
Longitudinal grating, galvanised	1000	249	20	1898	7,6	69050

DACHFIX® STEEL 255

Accessories

Drain box, base



Drain box for type 45, 75

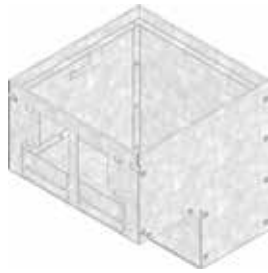

Drain box for type 100, 150



Drain box for type 100, 150 with paveable cover

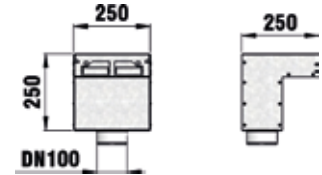

	Length mm	Width mm	Height mm	Weight kg	Item-No. galvanised	Item-No. stainless steel
Drain box for type 45, 75	250	250	250	2,3	65501	65508
Drain box for type 100, 150	250	250	250	2,4	65504	65511
Drain box for type 100, 150 with paveable cover	250	250	250	6,1	65505	65515

The quality of stainless steel material corresponds to CNS 1.4301.

DACHFIX® Drain box, grating



Slotted grating



Mesh grating,
MW 30/10

	Length mm	Width mm	Height mm	Intake cross-sect. cm ² /m	Weight kg	Item-No. galvanised	Item-No. stainless steel
Slotted grating	242	242	20	116	1,1	60524	60534
Mesh grating, MW 30/10	242	242	20	398	1,2	60521	60531

The quality of stainless steel material corresponds to CNS 1.4301.

DACHFIX® STEEL 255

Accessories

End caps



End cap type 45, closed, galvanised

End cap type 75, closed, galvanised

End cap type 150, closed, galvanised

	Length mm	Width mm	Height mm	Weight kg	Item No.
End cap type 45, closed, galvanised	-	-	-	0,2	65419
End cap type 75, closed, galvanised	-	-	-	0,2	65444
End cap type 100, closed, galvanised	-	-	-	0,3	65469
End cap type 150, closed, galvanised	-	-	-	0,4	65494

Further accessories

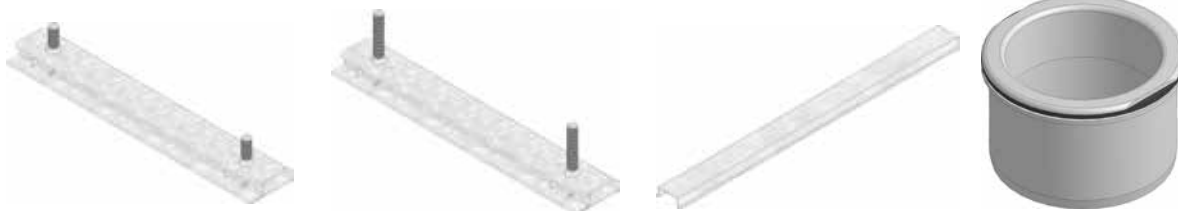

Height adjusting set DACHFIX STEEL 255, type 45, galvanised (2 pieces per metre required)

Height adjusting set DACHFIX STEEL 255, type 75, 100, 150, galvanised (2 pieces per metre required)

Cross-intersection channel, galvanised

Screw socket DN 70

	Length mm	Width mm	Height mm	Weight kg	Item-No. galvanised	Item-No. stainless steel
Height adjusting set DACHFIX STEEL 255, type 45, galvanised (2 pieces per metre required)	45	248	36	0,3	65562	-
Height adjusting set DACHFIX STEEL 255, type 75, 100, 150, galvanised (2 pieces per metre required)	45	248	56	0,3	65582	-
Cross-intersection channel	1000	70	30	0,7	60800	60801
Locking handle, for DACHFIX STEEL 255	-	-	-	0,1	60415	60465
Locking handle set with bolt for mesh grating, galvanised	-	-	-	0,1	69103	-
Locking handle set with bolt for longitudinal grating	-	-	-	0,1	69119	-
Screw socket DN 70	-	-	-	0,1	1187	-
Screw socket DN 100, grey	-	-	-	0,1	1185	-
Adapter for screw socket DN 70 to pipe connection	-	-	-	0,1	1193	-
Adapter for screw socket DN 100 to pipe connection	-	-	-	0,1	1192	-
Leaf trap for screw socket DN 70, grey	-	-	-	-	1188	-
Leaf trap for screw socket DN 100, grey	-	-	-	-	1190	-

The quality of stainless steel material corresponds to CNS 1.4301.

Installation examples **DACHFIX®**STEEL Channels

Installation situation A:

Drainage via cross-intersection channel and **DACHFIX®**POINT

Drainage via cross-intersection channel and DACHFIX POINT

Loading:
walkable, wheelchair accessible

Category according to EN 1433 / DIN 19580	A 15	B 125	C 250	D 400**	E 600	F 900	Applying to following systems:
Foundation: width x / thickness z / height y (in cm)							DACHFIX STEEL 115, 135, 155, 205, 255
The named concrete quality is a minimum quality							
EN 206-1 / DIN 1045-2	without danger of frost on the lateral support						
D	with danger of frost on the lateral support						
The installation examples / advise constantly are adapted to the technical conditions. With new editions older expenditures lose their validity. Before planning or installation please verify the current version at www.hauraton.com . In building construction is a sealing layer below the channels necessary.		Date: 31.08.2017	Our general installation instructions apply.			Format DIN A4	Werkstr. 13 76437 Rastatt Germany Tel. +49 (0) 72 22 9 58-0 Fax +49 (0) 72 22 9 58-100 info@hauraton.com
** Not for use in continuously frequented areas of carriageways or motorways		0000088594.dwg	EBBw	scale 1:8			
DF-STEEL Einbaubeispiel Terrassen/Balkone Entwässerung über Stichkanal und DACHFIX POINT							

Installation situation B

Drainage without channel connection, 5 cm threshold

Drainage without channel connection, 5 cm threshold

Loading:
walkable, wheelchair accessible

Category according to EN 1433 / DIN 19580	A 15	B 125	C 250	D 400**	E 600	F 900	Applying to following systems:
Foundation: width x / thickness z / height y (in cm)							DACHFIX STEEL 115, 135, 155, 205, 255
The named concrete quality is a minimum quality							
EN 206-1 / DIN 1045-2	without danger of frost on the lateral support						
D	with danger of frost on the lateral support						
The installation examples / advise constantly are adapted to the technical conditions. With new editions older expenditures lose their validity. Before planning or installation please verify the current version at www.hauraton.com . In building construction is a sealing layer below the channels necessary.		Date: 31.08.2017	Our general installation instructions apply.			Format DIN A4	Werkstr. 13 76437 Rastatt Germany Tel. +49 (0) 72 22 9 58-0 Fax +49 (0) 72 22 9 58-100 info@hauraton.com
** Not for use in continuously frequented areas of carriageways or motorways		0000088610.dwg	EBBw	scale 1:8			
DF-STEEL Einbaubeispiel Fassaden, Ein-/Ausgänge Entwässerung ohne Rinnenanschluss, 5 cm Schwelle							

Installation situation C:

Drainage via channel connection, vertical, level entrance (0 cm)

Drainage via channel connection, vertical, level entrance (0 cm)

Loading:
walkable, wheelchair accessible

Category according to EN 1433 / DIN 19580	A 15	B 125	C 250	D 400**	E 600	F 900	Applying to following systems:
Foundation: width x / thickness z / height y (in cm)							DACHFIX STEEL 115, 135, 155, 205, 255
The named concrete quality is a minimum quality							
EN 206-1 / DIN 1045-2	without danger of frost on the lateral support						
	with danger of frost on the lateral support						
<small>The installation examples / advise constantly use adapted to the technical conditions. With new editions older specifications lose their validity. Before planning or installation please verify the current version at www.hauraton.com in building construction is a sealing layer below the channels necessary.</small>							Date: 31.08.2017 Our general installation instructions apply.
<small>** Not for use in continuously frequented areas of carriageways or motorways</small>							Format DIN A4 scale 1:8 Werkstr. 13 76437 Rastatt Germany Tel: +49 (0) 72 22 9 58-0 Fax: +49 (0) 72 22 9 58-100 info@hauraton.com
0000088603.dwg EBBw							
DF-STEEL Einbaubeispiel Fassaden, Ein-/Ausgänge Entwässerung über Rinnenanschluss, senkrecht, schwellenloser Übergang (0 cm)							

Installation situation D:

Drainage via drain box, horizontal connection

Drainage via drain box, horizontal connection

Loading:
walkable, wheelchair accessible

Category according to EN 1433 / DIN 19580	A 15	B 125	C 250	D 400**	E 600	F 900	Applying to following systems:
Foundation: width x / thickness z / height y (in cm)							DACHFIX STEEL 115, 135, 155, 205, 255
The named concrete quality is a minimum quality							
EN 206-1 / DIN 1045-2	without danger of frost on the lateral support						
	with danger of frost on the lateral support						
<small>The installation examples / advise constantly use adapted to the technical conditions. With new editions older specifications lose their validity. Before planning or installation please verify the current version at www.hauraton.com in building construction is a sealing layer below the channels necessary.</small>							Date: 31.08.2017 Our general installation instructions apply.
<small>** Not for use in continuously frequented areas of carriageways or motorways</small>							Format DIN A4 scale 1:8 Werkstr. 13 76437 Rastatt Germany Tel: +49 (0) 72 22 9 58-0 Fax: +49 (0) 72 22 9 58-100 info@hauraton.com
0000088596.dwg EBBw							
DF-STEEL Einbaubeispiel Fassaden, Ein-/Ausgänge Entwässerung über Ablaufbox, Anschluss waagrecht							

Installation examples **DACHFIX®**STEEL Channels

Installation situation E:

Drainage via drain box, vertical connection

Drainage via drain box, vertical connection

Loading:
walkable, wheelchair accessible

Classification of mortar, drain capacity according to DIN 18130-1

-0.02

Paving

Crushed stone bedding

Base course

outlet pipe DN 110

Frost resistant sub-base

Category according to EN 1433 / DIN 19580	A 15	B 125	C 250	D 400**	E 600	F 900	Applying to following systems:
Foundation: width x / thickness z / height y (in cm)							DACHFIX STEEL 115, 135, 155, 205, 255
The named concrete quality is a minimum quality							
EN 206-1 / DIN 1045-2							
without danger of frost on the lateral support							
with danger of frost on the lateral support							
The installation examples / advise constantly are adapted to the technical conditions. With new editions older expenditures lose their validity. Before planning or installation please verify the current version at www.hauraton.com . In building construction is a sealing layer below the channels necessary.	Date: 31.08.2017		Our general installation instructions apply.			Format DIN A4	<p>Werkstr. 13 76437 Rastatt Germany</p> <p>Tel: +49 (0) 72 22 9 58-0 Fax: +49 (0) 72 22 9 58-100 info@hauraton.com</p>
000088601.dwg	EBBw					scale 1:8	
DF-STEEL Einbaubeispiel Fassaden, Ein-/Ausgänge Entwässerung über Ablaufbox, Anschluss senkrecht							

Your way to the tender text at hauraton.com

1 a) Product known

- Go to the product page.



b) Product unknown

- Go to the tender assistant.



- Select application
- Choose application area, load class and nominal width
- Select from suggested systems/products

2 Select desired format and add to my documents



3 Download tender text

- Go to „My documents“ and download tender text.

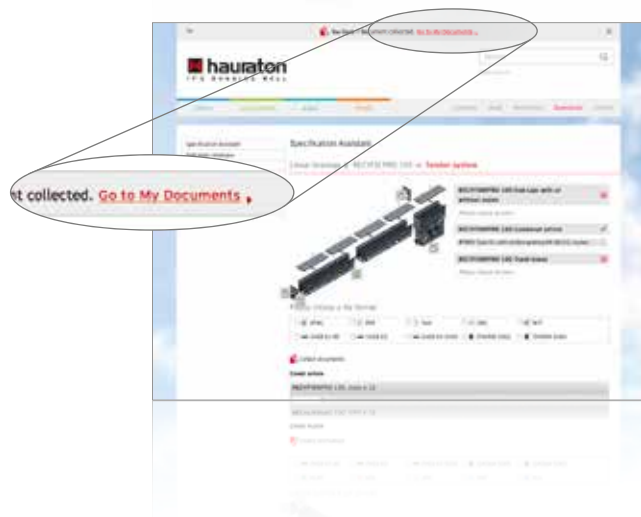

**HAURATON GmbH & Co. KG**

Werkstraße 13

76437 Rastatt

Germany

Tel. +49 7222 958 0

Fax +49 7222 958 100

export@hauraton.com

www.hauraton.com